

BURLEY®

Since 1978

2014-Present Replacement Parts **Flatbed**

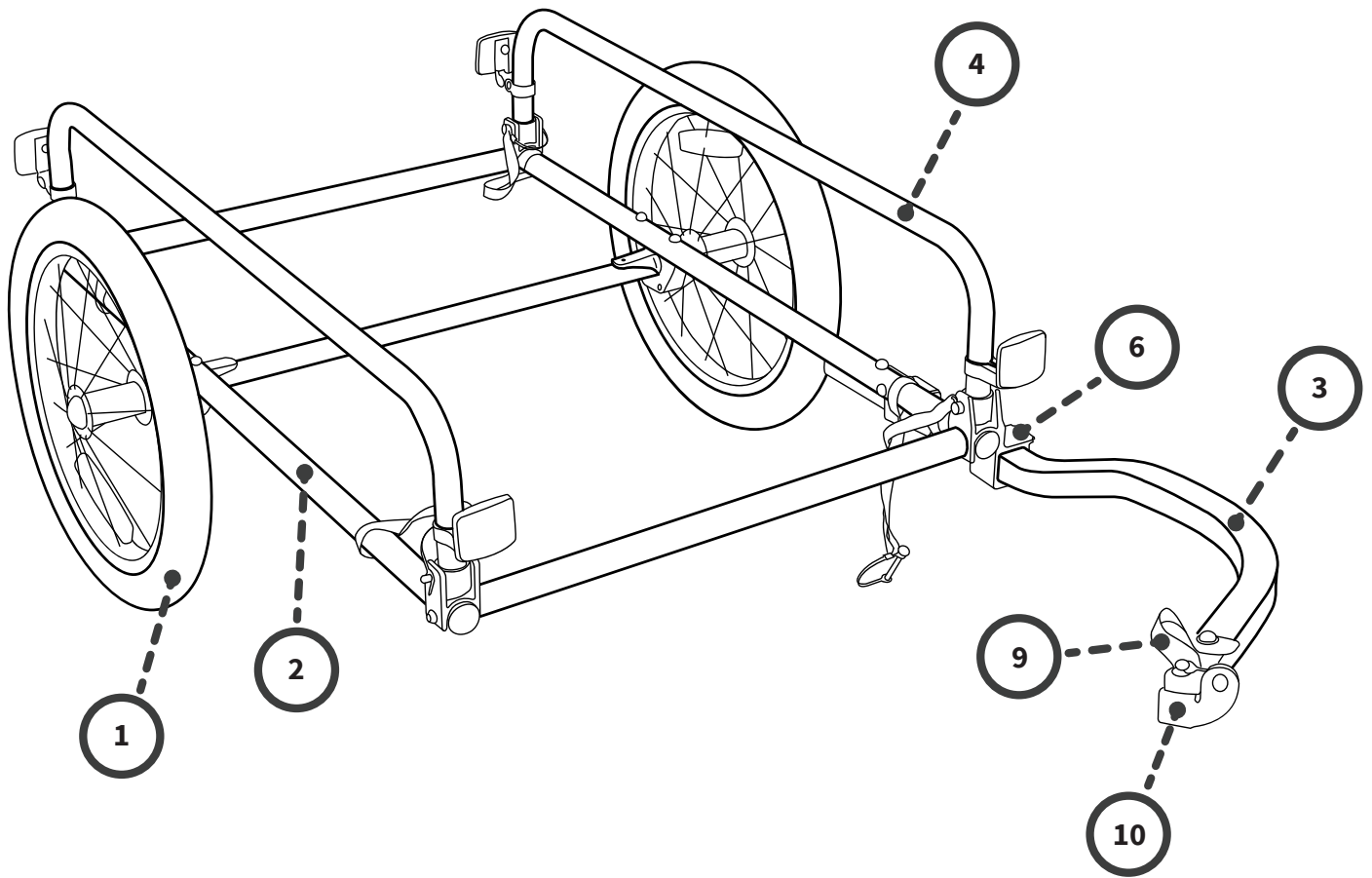

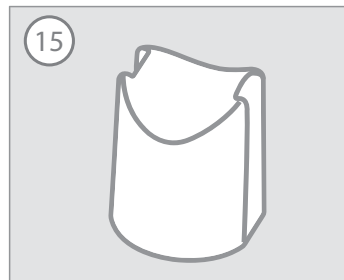
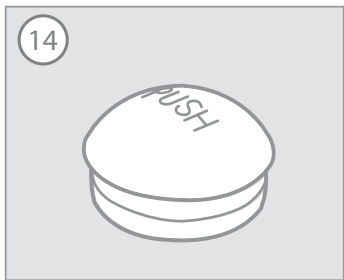
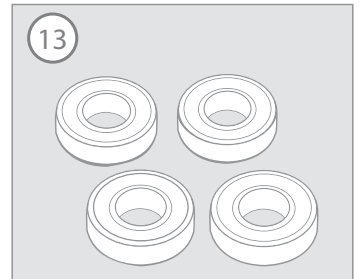
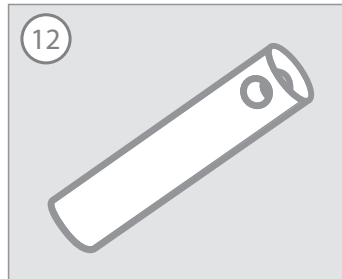
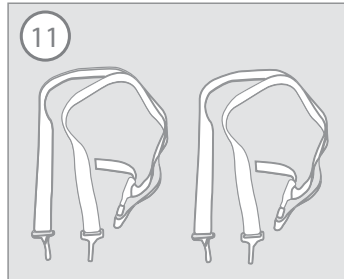
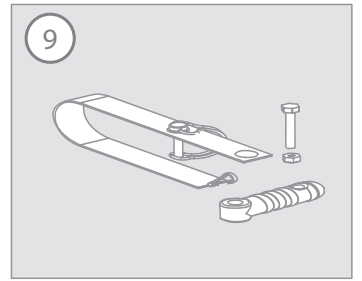
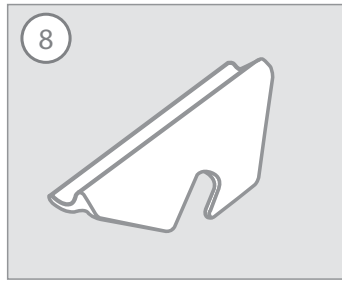
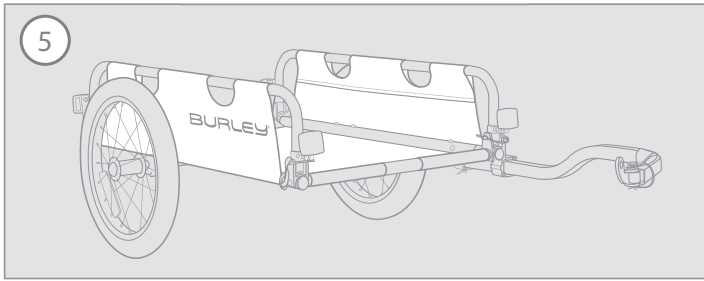

2014-Present Replacement Parts: Flatbed

Number	Description	Part Number		
		2008	2009-13	2014-
1	16" Wheel Assembly	160015		160050
2	Main Frame Assembly	950036	950074	250371
3	Towbar Assembly	250229	250122	
4	Side Rails	950034	950073	
5	Fabric Floor	950031	950096	250370
6	Towbar Reciever Kit, Left	950033	950005	
7	Axle Assembly	n/a	950097	950077
8	Dropouts	4010212	n/a	
9	Flex Connector w/ Hitch Safety Strap	950038		
10	Steel Hitch, 12.2mm	960116		
11	Hold Down Straps	4130010		
12	Side Rail Post	950026	n/a	
13	Wheel Bearing Kit	950121		
14	Dust Cap Covers	n/a		950123
15	Frame End Cap	n/a	120006	